



# VICTOR

CENNIK PRODUCENTA

**Cennik ważny od 15.07.2021**

**CONTINO**   
meble biurowe

**CONTINO.PL**

tel. 605 436 796

tel. 605 640 958

e-mail: [biuro@contino.pl](mailto:biuro@contino.pl)

**LADY:**BLATY I NOGI

Płyta 25mm, PCV 2mm

BLENDA

Płyta 18mm, PCV 1mm

Cokół z maty aluminiowanej wys. 10cm

Stopki chromowane do wypoziomowania w zakresie 0-15mm

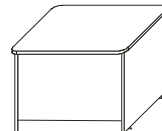
**LADY BONIOWANE:**BLATY I NOGI

Płyta 25mm, PCV 2mm

BLENDA

Płyta 18mm, PCV 1mm

Cokół z maty aluminiowanej wys. 10cm

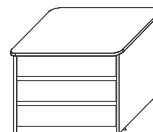

Stopki chromowane do wypoziomowania w zakresie 0-15mm

**NADSTAWKI:****PŁYTA:**

Blaty i boki płyta 25mm, PCV 2mm

Blenda płyta 18mm, PCV 1mm

**BONIOWANE:**

Blaty i boki płyta 25mm, PCV 2mm

Bonie z płyty 18mm, PCV 2mm - 2 bonie, między boniami wstawka z maty aluminiowanej

OPCJA - wstawka między boniami z lakierowanego MDF wg kolorystyki RAL lub NCS - bez dopłat

**METAL:**

Blaty i boki płyta 25mm, PCV 2mm

Blacha perforowana 1.2 mm malowana proszkowo (testurizate) wg wzornika

Standardowy wzór perforacji - "**PROSTOKĄT**", opcjonalnie "kwadrat", "fasolka" lub "paski"**BLAT SZKLANY:**

OPCJA - blat szklany- szkło hartowane gr. 8mm, narożniki promień R4, szkło na dystansach kwadratowych H6cm

**BIURKA PŁYTA:**BLATY I NOGI

Płyta 25mm, PCV 2mm

BLENDA

Płyta 18mm, PCV 1 mm

Stopki chromowane do wypoziomowania w zakresie 0-15mm

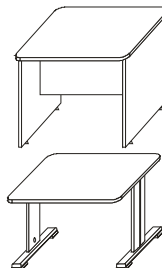
**BIURKA STELAŻ - STOPA METALOWA:**BLATY

Płyta 25mm, PCV 2mm

STELAŻ

Stelaż metalowy malowany proszkowo (testurizate) wg wzornika

Noga z możliwością prowadzenia okablowania pionowego

Belka podblatowa z możliwością prowadzenia okablowania poziomego

OPCJA - chromowanie stopy stelaża (za dopłatą - poz. 35 w cenniku)

Do biurek należy domawiać blendy z cennika AKCESORIÓW.

**DOSTAWKI:****KONTENERY:**SZUFLADY

PŁYTA - prowadnice rolkowe 3/4 wysuwu

PLASTIK "PP" - szuflada OnSide II z tworzywa PP, prowadnice kulkowe, pełen wysuw

UCHWYTYUchwyt nr 1 satyna, uchwyt nr 2 czarny, uchwyt nr 3 chrom mat,  
uchwyt 'J' chrom mat, uchwyt 'T' chrom mat;

Wszystkie blaty w systemie VICTOR mają zaoblone narożniki (promień R4).

**PAKOWANIE:**

Lady, biurka i dostawki - paczka

Narożniki lad i nadstawek oraz nadstawki z blachą perforowaną - w całości;

Kontenery i szafki żaluzjowe - w całości

**WAŻNE:**

Prosimy dołączać do zamówień aranżacje z ustawieniem lad.

TERMIN REALIZACJI

**do 14 dni roboczych (do potwierdzenia)**

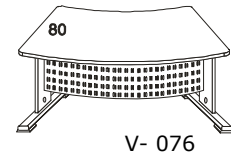
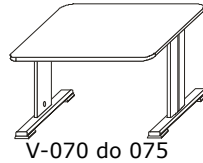
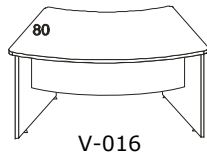
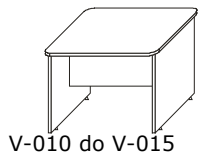

L.p.	Biurka	Płyta 25mm Symbol	Cena netto PLN	Stopy z kanałem kablowym Symbol	Cena netto PLN
1.	80x80x75h	V-010	402,00	V-070	799,00
2.	100x80x75h	V-011	440,00	V-071	857,00
3.	120x80x75h	V-012	479,00	V-072	888,00
4.	140x80x75h	V-013	513,00	V-073	929,00
5.	160x80x75h	V-014	551,00	V-074	964,00
6.	180x80x75h	V-015	587,00	V-075	985,00
7.	160x90x75h	V-016	762,00	V- 076	1 535,00

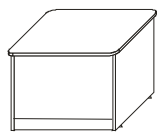

V-040 do V-045

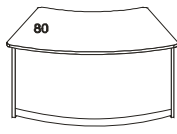

V-046

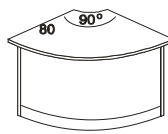

V-047

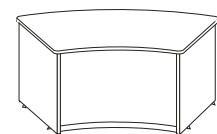

V-048

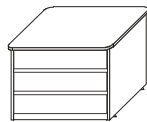

V-040B do V-045B

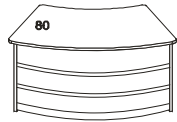

V-046B

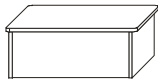

V-060 do V-065



V-066

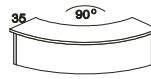

V-067



V-088

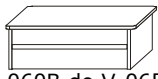

V-060B do V-065B



V-066B

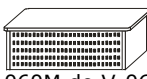

V-060M do V-065M



V-066M



V-067M



V-088M

### LADY RECEPCYJNE







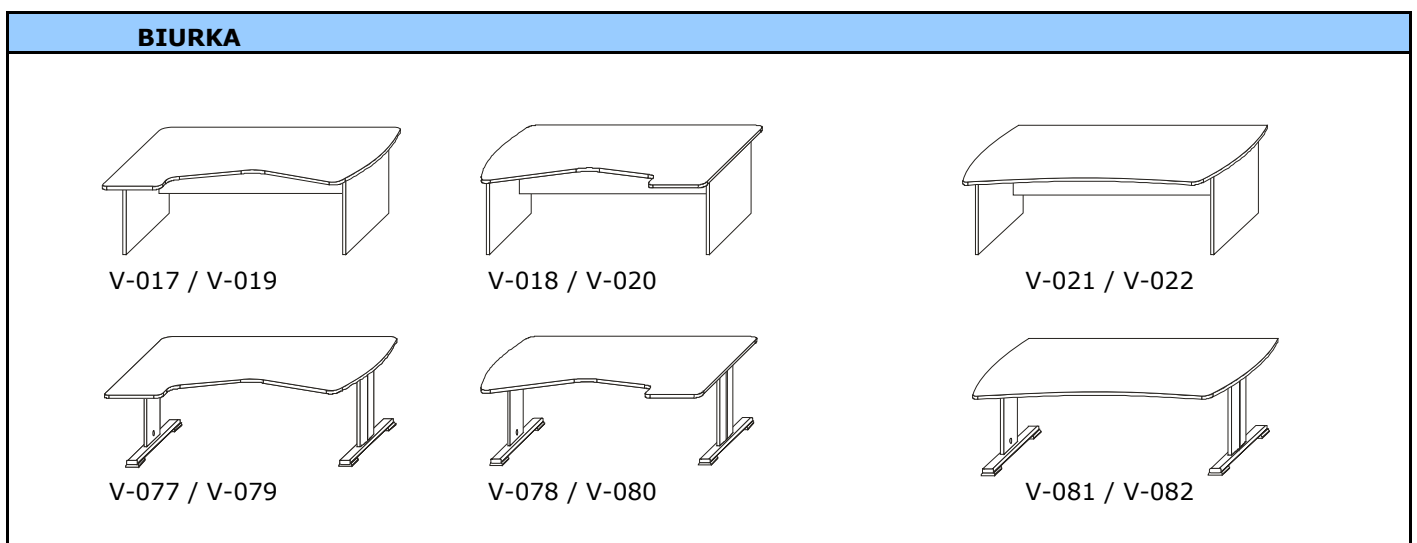



L.p.	Lady - front płyta			Lady - front boniowany		
1.	80x80x75h	V-040	627,00	80x80x75	V-040 B	844,00
2.	100x80x75h	V-041	719,00	100x80x75	V-041 B	988,00
3.	120x80x75h	V-042	811,00	120x80x75	V-042 B	1130,00
4.	140x80x75h	V-043	901,00	140x80x75	V-043 B	1269,00
5.	160x80x75h	V-044	1002,00	160x80x75	V-044 B	1421,00
6.	180x80x75h	V-045	1088,00	180x80x75	V-045 B	1560,00
7.	160x90x75h	V-046	1804,00	160x90x75	V-046 B	2895,00
8.	100x100x75h	V-047	1338,00			
9.	160x90x75h	V-048	1763,00			





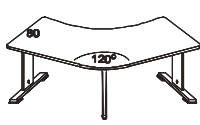

NADSTAWKI RECEPCYJNE O WYSOKOŚCI 35cm							
L.p.		Front płyta		Front boniowany		Front blacha perforowana	
1	80x35x35h	V-060	206,00	V-060 B	328,00	V-060 M	396,00
2	100x35x35h	V-061	239,00	V-061 B	393,00	V-061 M	482,00
3	120x35x35h	V-062	264,00	V-062 B	447,00	V-062 M	556,00
4	140x35x35h	V-063	307,00	V-063 B	521,00	V-063 M	650,00
5	160x35x35h	V-064	342,00	V-064 B	585,00	V-064 M	736,00
6	180x35x35h	V-065	373,00	V-065 B	649,00	V-065 M	820,00
7	160x50x35h	V-066	714,00	V-066 B	1295,00	V-066 M	1227,00
8	100x100x35h	V-067	715,00			V-067 M	1055,00
9	130x50x35h	V-088	684,00			V-088 M	1030,00

NADSTAWKI RECEPCYJNE O WYSOKOŚCI 46cm							
L.p.		Front płyta		Front boniowany		Front blacha perforowana	
1	80x35x46h	V-060W	224,00	V-060 WB	385,00	V-060 WM	438,00
2	100x35x46h	V-061W	261,00	V-061 WB	459,00	V-061 WM	530,00
3	120x35x46h	V-062W	286,00	V-062 WB	521,00	V-062 WM	613,00
4	140x35x46h	V-063W	333,00	V-063 WB	608,00	V-063 WM	717,00
5	160x35x46h	V-064W	371,00	V-064 WB	681,00	V-064 WM	810,00
6	180x35x46h	V-065W	408,00	V-065 WB	759,00	V-065 WM	901,00
7	160x50x46h	V-066W	779,00	V-066 WB	1508,00	V-066 WM	1350,00
8	100x100x46h	V-067W	780,00			V-067 WM	1162,00
9	130x50x46h	V-088W	747,00			V-088 WM	1132,00

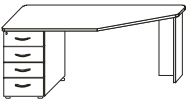
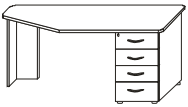
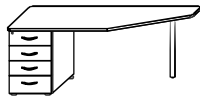
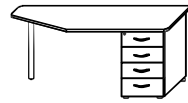

L.p.	Podstawa płyta 25mm		Podstawa stelaż metalowy VICTOR		
1.	160x90x75h	V-017	653,00	V-077	987,00
2.	160x90x75h	V-018	653,00	V-078	987,00
3.	180x90x75h	V-019	691,00	V-079	1021,00
4.	180x90x75h	V-020	691,00	V-080	1021,00
5.	160x85x75h	V-021	648,00	V-081	942,00
6.	180x85x75h	V-022	684,00	V-082	987,00

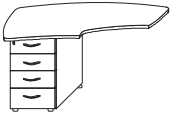
L.P.	ELEMENT	SYMBOL	WYMIAR dłxgłxwys	NAZWA I OPIS		CENA NETTO PLN
1.		V-051	ø 120x75h	Dostawka konferencyjna 3/4	do pozycji V-016, V-046, V-076	762,00
2.		V-052	ø 120x75h	Dostawka konferencyjna 3/4		762,00
3.		V-055	172x90x75h	Dostawka łukowa		848,00
4.		V-057	ø 120x75h	Dostawka łukowa	do pozycji od V-017 do V-022, od V-077 do V-082	761,00
5.		V-058	ø 120x75h	Dostawka łukowa		761,00
6.		V-068	56x39x35h	Nadstawka recepcyjna prawa		245,00
		V-068W	56x39x42h			270,00
7.		V-069	56x39x35h	Nadstawka recepcyjna lewa		245,00
		V-069W	56x39x42h			270,00
8.		V-113	90x45x75h	Szafka z żaluzją	zamek w standardzie	1 067,00
9.		V-106	74x60x162h	Szafka kuchenna z żaluzją (mobilna)	możliwość wstawienia lodówki 60 L	3 220,00
14.		V-111	45x45x75h	Kontener	szuflady z płyty	625,00
15.						
16.		V-053	205x120x75h	Biuorko kształtowe 120°		1690,00

L.P.	ELEMENT	SYMBOL	WYMIAR dłxgłxwys	NAZWA I OPIS		CENA NETTO
						PLN
17.		V-104	45x80x75h	Kontener	szuflady z płyty	750,00
18.		V-104 PP			szuflady z tworzywa PP, prowadnica kulkowa, pełen wysuw	1 065,00
19.		V-105	44x60x134h	Szafka mobilna z żaluzją (zamek centralny i zamek żaluzjowy)	szuflady z płyty	1 480,00
20.		V-105 PP			szuflady z tworzywa PP, prowadnica kulkowa, pełen wysuw	1 641,00
21.		V-035	180x50x75h	Dostawka boczna z kontenerem lewa	szuflady z płyty	843,00
22.		V-036	180x50x75h	Dostawka boczna z kontenerem prawa	szuflady z płyty	843,00
23.		V-037	180x50x75h	Dostawka boczna z kontenerem lewa	szuflady z płyty	879,00
24.		V-038	180x50x75h	Dostawka boczna z kontenerem prawa	szuflady z płyty	879,00
25.		V-112	90x45x75h	Dostawka boczna	szuflady z płyty	804,00
26.		V-115	142x60x75h	Dostawka boczna	szuflady z płyty	897,00
27.		V-116	142x60x75h	Dostawka boczna	szuflady z płyty	897,00
28.	Lodówka 60L					970,00
29.	Chromowanie stóp w stelażu metalowym					528,00
30.	Oświetlenie blatu	cena za 1 metr bieżący oświetlenia LED				260,00
31.		zasilacz				146,00

**UWAGI:**

Proponowana lodówka jest wstawiana do szafki bez łączenia z drzwiczkami - nie jest to typowa lodówka do zabudowy.

PRZYKŁADOWE USTAWIENIA MEBLI VICTOR

